	SPECIFICATION YTTERBIUM FIBER LASER Model YLR-4000	Spec:	G22-29729
		Revision:	00
		Issue date:	09.01.2020
		Page:	1 of 4

1. Optical characteristics

N	Characteristics	Test conditions	Symbol	Min.	Typ.	Max.	Unit
1	Operation Mode			CW / Modulated			
2	Polarization			Random			
3	Nominal Output Power		P_{nom}	4000			W
4	Emission Wavelength	Output power: 4000 W	λ		1070		nm
5	Emission Linewidth	Output power: 4000 W	$\Delta\lambda$		1.5	5	nm
6	Short-term Power Instability	Output power: 4000 W Frequency range: 10 kHz – 20 MHz			1.5	3.0	rms %
7	Long-term Power Instability	Output power: 4000 W Time interval: 4 hrs (T=Constant)			±1	±3	%
8	Switching ON/OFF Time	Output power: 4000 W			30	50	µs
9	Power Modulation Rate	Output power: 4000 W				10	kHz
10	Red Guide Laser Power			0.1	-	1.0	mW

2. Optical output

N	Characteristics	Test conditions	Symbol	Min.	Typ.	Max.	Unit
1	Beam Quality	Option 1 – 50 µm core fiber Option 2 – 100 µm core fiber Option 3 – 200 µm core fiber	BPP	1.7 3.4 6	2.4 4.8 9.6	2.8 5.6 11.2	mm x mrad
2	Delivery Fiber Length		L		5.0	TBD	m
3	Delivery Cable Bending Radius			80			mm
4	Output Fiber Termination			QBH-compatible connector			

3. General characteristics

N	Characteristics	Min.	Typ.	Max.	Unit
1	Operating Ambient Temperature Range	10		50	°C
2	Humidity	10		95	%
3	Storage Temperature	- 40		+ 75	°C
4	Dimensions, WxDxH:	4U 19" rack mountable 448 x 801 x 177			mm
5	Weight			80	kg
6	Laser "Cold Start" Temperature	20			°C

CONFIDENTIAL: This document and any data disclosed therein is the property of IPG Photonics Corporation and its affiliates, and constitute and contain proprietary information. Neither receipt nor possession of this document confers or transfers any right to duplicate, use, or disclose any information contained herein except as expressly authorized in writing by IPG Photonics Corporation.
No representations and warranties are made hereby, except in a binding purchase order.

	SPECIFICATION YTTERBIUM FIBER LASER Model YLR-4000	Spec:	G22-29729
		Revision:	00
		Issue date:	09.01.2020
		Page:	2 of 4

4. Cooling

N	Characteristics	Test conditions	Symbol	Min.	Typ.	Max.	Unit
1	Method			Tap or DI-water			
2	Water Temperature *always above dew point			21*	22	25	°C
3	Water Pressure			1.5		3.5	bar
4	Water Flow			15			l/min
5	Chiller Cooling Capacity			7.5			kW

5. Electrical characteristics

N	Characteristics	Min.	Typ.	Max.	Unit
1	Operating Voltage, 3-phase	400-480 VAC, 50/60 Hz			
2	Maximum Power Consumption		10	11.5	kW
			11	12.7	kVA
3	Control	Analog / RS-232 / Ethernet *			

* For details please refer to YLR-Series User Guide.

6. External layout

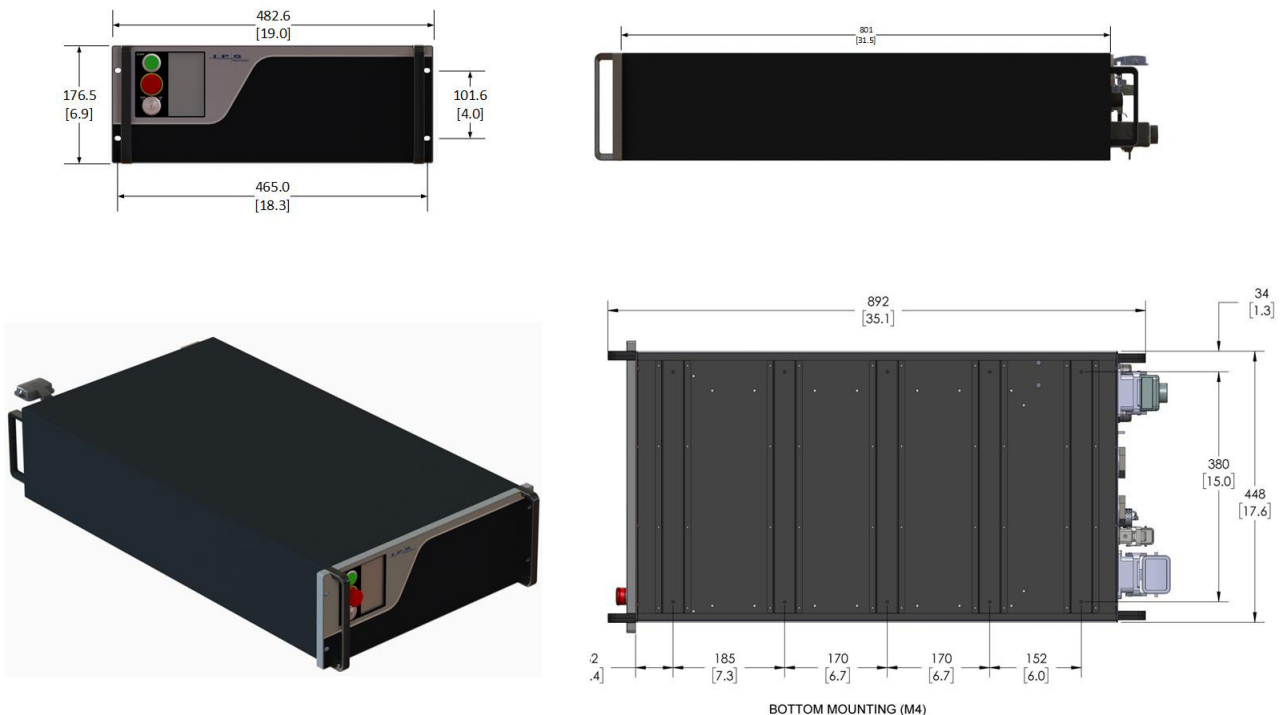

Laser cabinet

CONFIDENTIAL: This document and any data disclosed therein is the property of IPG Photonics Corporation and its affiliates, and constitute and contain proprietary information. Neither receipt nor possession of this document confers or transfers any right to duplicate, use, or disclose any information contained herein except as expressly authorized in writing by IPG Photonics Corporation.
 No representations and warranties are made hereby, except in a binding purchase order.



**SPECIFICATION
YTTERBIUM FIBER LASER
Model YLR-4000**

Spec:	G22-29729
Revision:	00
Issue date:	09.01.2020
Page:	3 of 4

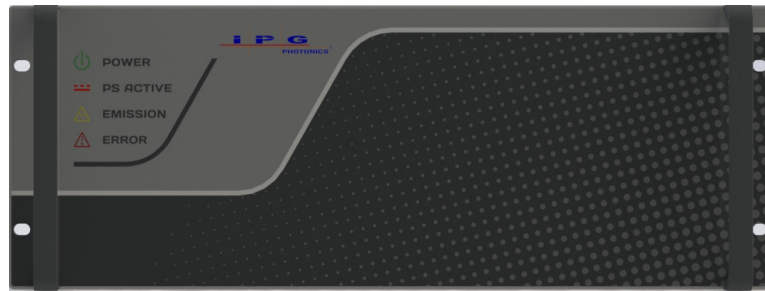

Standard configuration without touch-screen display

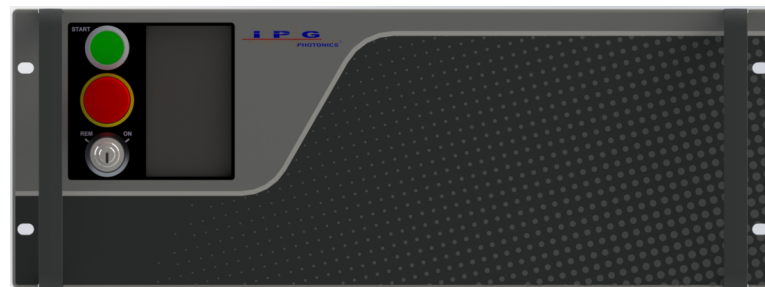

Optional configuration with touch-screen display

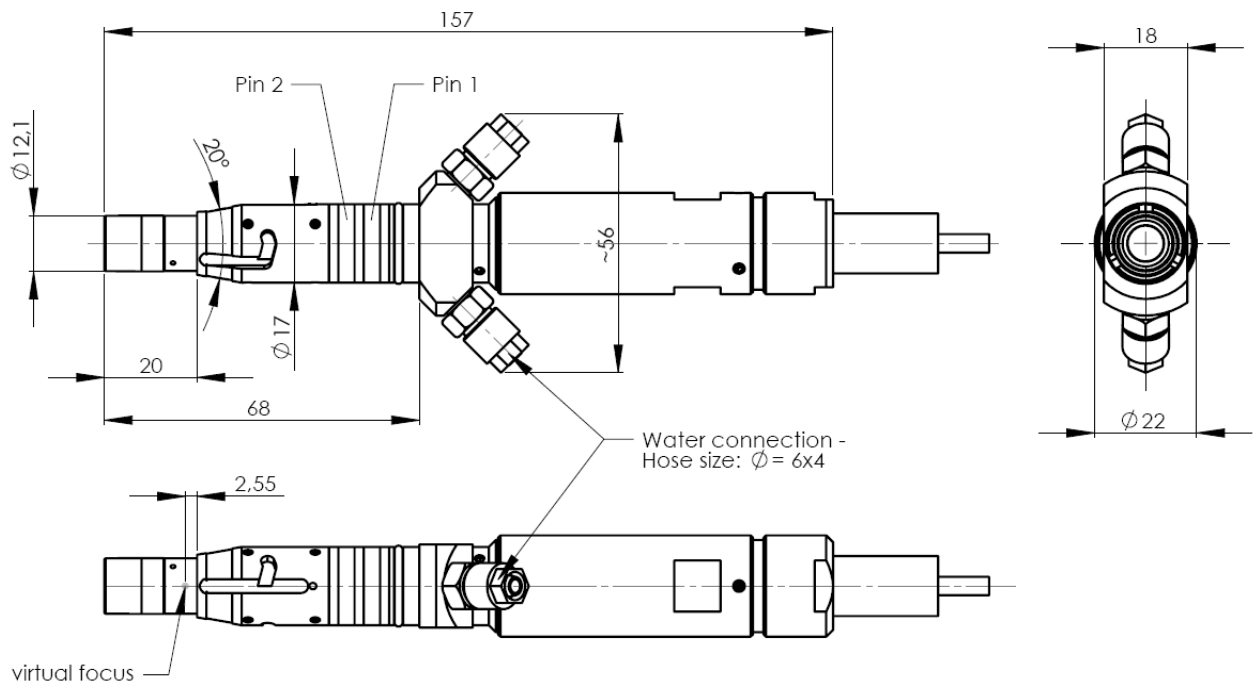

QBH-compatible connector, water cooled

CONFIDENTIAL: This document and any data disclosed therein is the property of IPG Photonics Corporation and its affiliates, and constitute and contain proprietary information. Neither receipt nor possession of this document confers or transfers any right to duplicate, use, or disclose any information contained herein except as expressly authorized in writing by IPG Photonics Corporation.
No representations and warranties are made hereby, except in a binding purchase order.

	SPECIFICATION YTTERBIUM FIBER LASER Model YLR-4000	Spec: Revision: Issue date: Page:	G22-29729 00 09.01.2020 4 of 4
---	---	--	---

7. Beam management accessories

N	Type	Model
1	Attachable Collimator	D25F50, D25F60, D25F85, D50F100, D50F120, D50F160, D50F200
2	Compact Beam Coupler	BC1x112
3	Compact Beam Switch	BS1xN12 N – number of output channels (1, 2, 3 or 4)

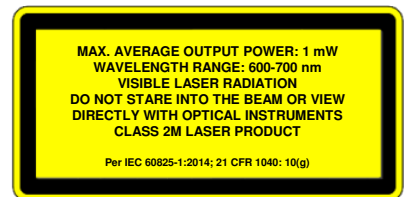
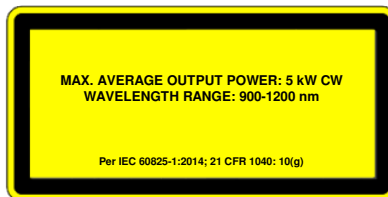
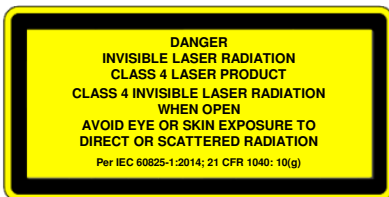

CONFIDENTIAL: This document and any data disclosed therein is the property of IPG Photonics Corporation and its affiliates, and constitute and contain proprietary information. Neither receipt nor possession of this document confers or transfers any right to duplicate, use, or disclose any information contained herein except as expressly authorized in writing by IPG Photonics Corporation.

No representations and warranties are made hereby, except in a binding purchase order.